

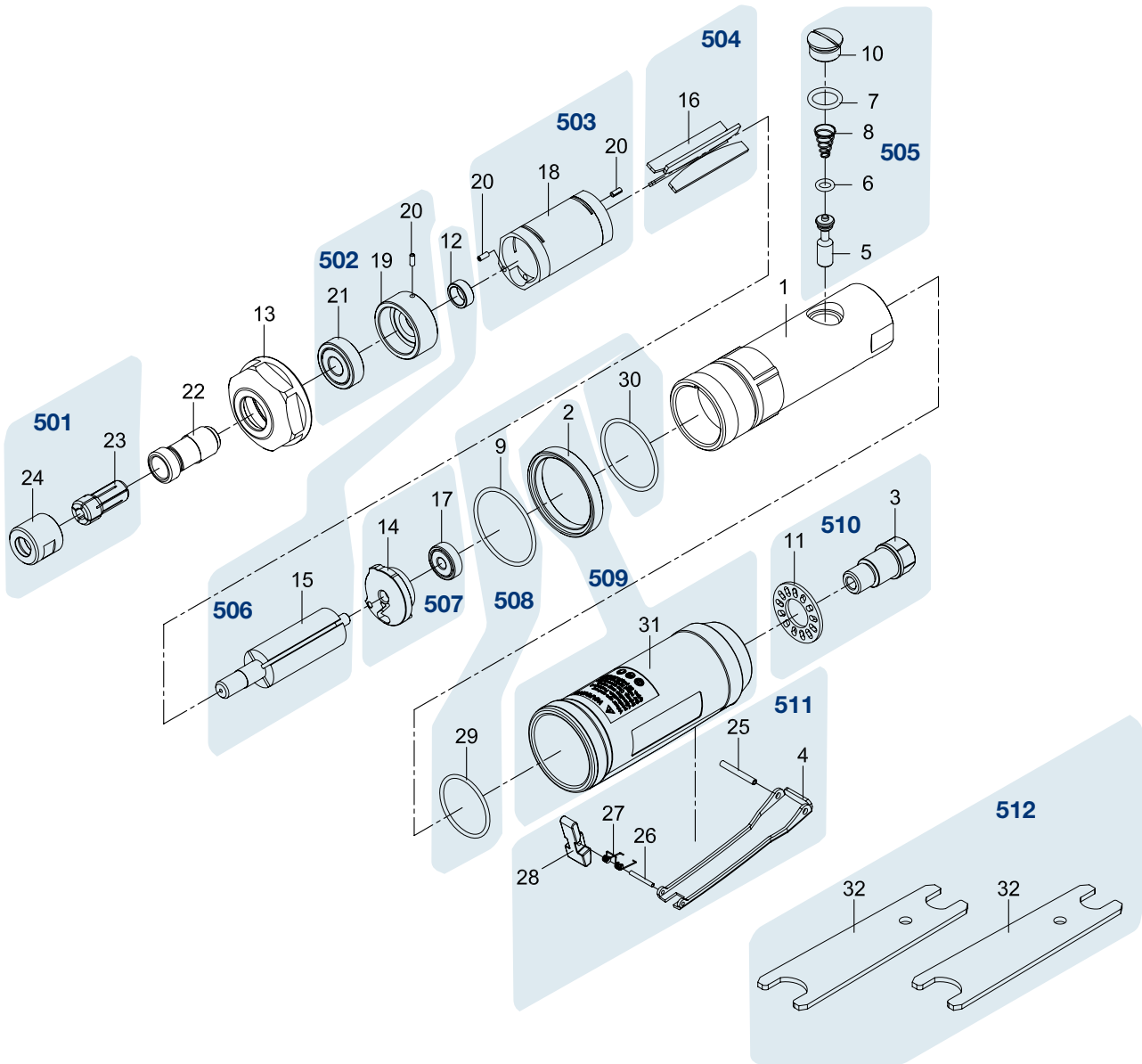



Ersatzteile 9032 P-1



	<i>HAZET</i> No.	Bezeichnung	Name	Désignation	
1	9032P-01	Gehäuse	<i>Housing</i>	<i>Boîtier</i>	1
13	9032P-02	Befestigungsmutter	<i>Clamp Nut</i>	<i>Écrou de fixation</i>	1
22	9032P-03	Spannfutter Halter	<i>Collett holder</i>	<i>Support de mandrin</i>	1
501	9032P-04/2	Spannfutter Inhalt: 23, 24	<i>Collet</i> <i>Contents: 23, 24</i>	<i>Mandrin</i> <i>Contenu: 23, 24</i>	2
502	9032P-05/3	Vordere Endplatte Inhalt: 19, 20, 21	<i>Front End Plate</i> <i>Contents: 19, 20, 21</i>	<i>Plaque d'extrémité avant</i> <i>Contenu: 19, 20, 21</i>	3
503	9032P-06/3	Zylindereinheit Inhalt: 18, 20 (2x)	<i>Cylinder Unit</i> <i>Contents: 18, 20 (2x)</i>	<i>Unité de vérin</i> <i>Contenu: 18, 20 (2x)</i>	3
504	9032P-07/4	Lamellen Inhalt: 16 (4x)	<i>Blades</i> <i>Contents: 16 (4x)</i>	<i>Lamellen</i> <i>Contenu: 16 (4x)</i>	4
505	9032P-08/5	Ventileinheit Inhalt: 5, 6, 7, 8, 10	<i>Valve Unit</i> <i>Contents: 5, 6, 7, 8, 10</i>	<i>Unité de soupape</i> <i>Contenu: 5, 6, 7, 8, 10</i>	5



	HAZET No.	Bezeichnung	Name	Désignation	
506	9032P-09/2	Rotor mit Buchse Inhalt: 12, 15	<i>Rotor with bushing</i> Contents: 12, 15	<i>Rotor avec douille</i> Contenu: 12, 15	2
507	9032P-10/2	Hintere Endplatte Inhalt: 14, 17	<i>Rear End Plate</i> Contents: 14, 17	<i>Plaque d'extrémité arrière</i> Contenu: 14, 17	2
508	9032P-011/3	Dichtungs-Satz (O-Ring) Inhalt: 9 (Ø 40 x 2 mm), 29 (Ø 31,5 x 2 mm), 30 (Ø 35,5 x 2 mm)	<i>Gasket Set Contents:</i> 9 (Ø 40 x 2 mm), 29 (Ø 31,5 x 2 mm), 30 (Ø 35,5 x 2 mm)	<i>Jeu de joints Contenu:</i> 9 (Ø 40 x 2 mm), 29 (Ø 31,5 x 2 mm), 30 (Ø 35,5 x 2 mm)	3
509	9032P-012/2	Handgriff Inhalt: 2, 31	<i>Grip</i> Contents: 2, 31	<i>Poignée</i> Contenu: 2, 31	2
510	9032P-013/2	Lufteinlass Inhalt: 3, 11	<i>Air Inlet</i> Contents: 3, 11	<i>Admission d'air</i> Contenu: 3, 11	2
511	9032P-014/5	Betätigungshebel Inhalt: 4, 25, 26, 27, 28	<i>Throttle Lever</i> Contents: 4, 25, 26, 27, 28	<i>Gâchette</i> Contenu: 4, 25, 26, 27, 28	5
512	9032P-015/2	Spannschlüssel-Satz Inhalt: 32 (2x)	<i>Spanner set</i> Contents: 32 (2x)	<i>Jeu de clés de serrage</i> Contenu: 32 (2x)	2
Positionen, die keine HAZET No. haben, können nur über den HAZET-Service bestellt werden					



Zur Bestellung und für Rückfragen wenden Sie sich bitte an unsere Service-Abteilung.

 +49 (0) 21 91/7 92 355 •  +49 (0) 21 91/7 92 523 •  service-center@hazet.de

HAZET - WERK Hermann Zerver GmbH & Co. KG

 Güldenwerther Bahnhofstrasse 25 - 29 • D-42857 Remscheid • Germany

 +49 (0) 21 91 / 7 92-0 •  +49 (0) 21 91 / 7 92-375 (National) •  +49 (0) 21 91 / 7 92-400 (International)

 hazet.de •  info@hazet.de