

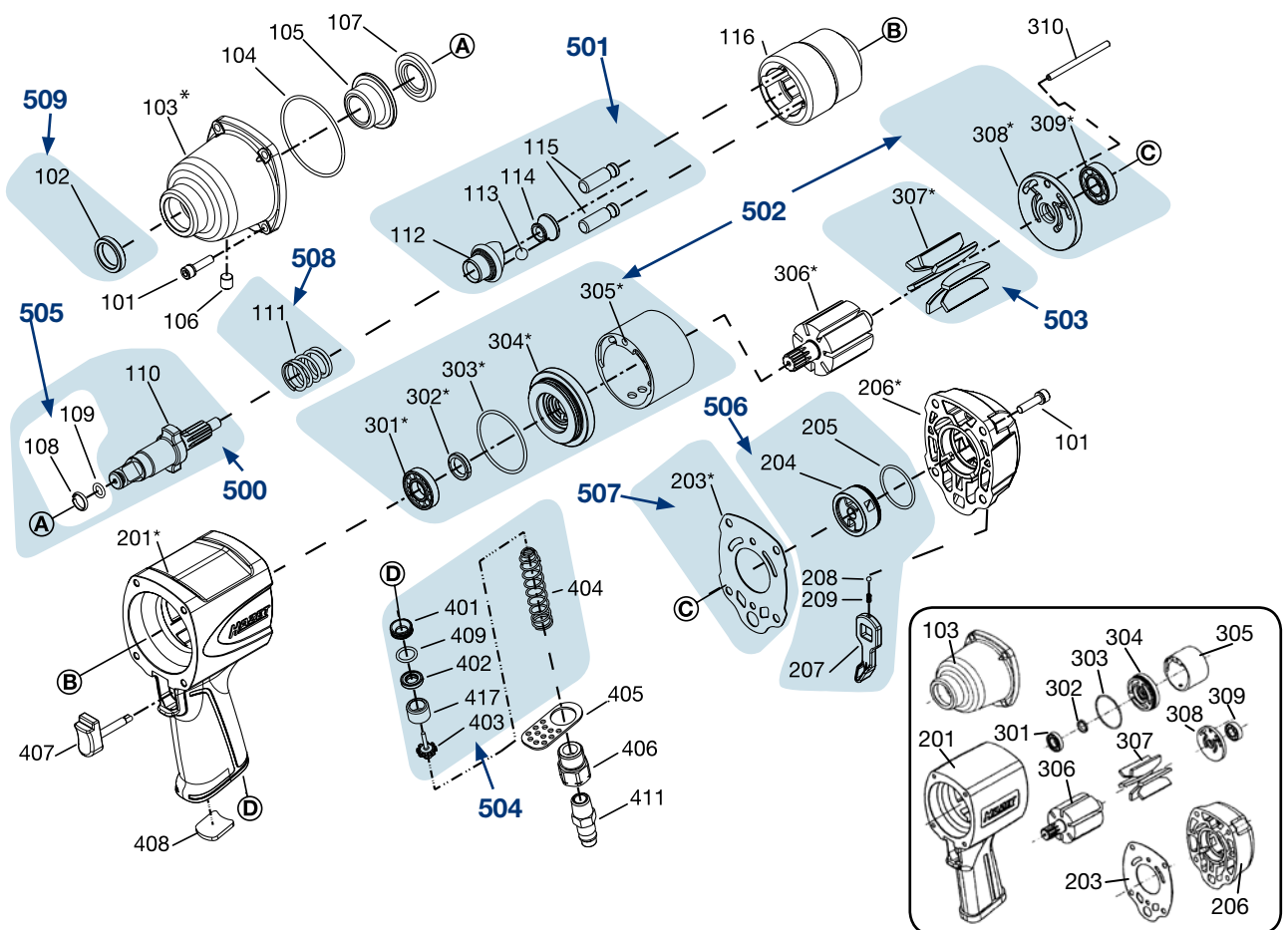









Erersatzteile 9012 SPC



	HAZET No.	Bezeichnung	Name	
101	9012SPC-07/8	Gehäuseschraube	Bolt Assy	8
103	9012SPC-08	Schlagwerkgehäuse	Hammer Case	1
103*	9012SPC-08N	Schlagwerkgehäuse	Hammer Case	1
104	9012SPC-09/15	O-Ring	O-Ring	1
105	9012SPC-010	Schlagwerkgehäuse-Buchse	Hammer Case Bushing	1
106	9012SPC-011/10	Hex. Soc. Hd. Schraube	Hex. Soc Hd. Screw	1
107	9012SPC-012/2	Unterlegscheibe	Washer	1
116	9012SPC-013	Schlagwerkkorb	Hammer Frame	1
201	9012SPC-014	Gehäuse	Housing	1
201*	9012SPC-014N	Gehäuse	Housing	1
206	9012SPC-015	Hinteres Gehäuseabdeckung	Rear Cover Unit	1
206*	9012SPC-015N	Hinteres Gehäuseabdeckung	Rear Cover Unit	1
306	9012SPC-016	Rotor	Rotor	1
306*	9012SPC-016N	Rotor	Rotor	1
310		Stift	Pin	1
405	9012SPC-017/5	Luftleitblech	Exhaust Deflector	1
406	9012SPC-018	Lufteinlaß	Air Inlet	1

	HAZET No.	Bezeichnung	Name	
407	9012SPC-019	Abzughebel	<i>Trigger</i>	1
408	9012SPC-020/10	Auslaßsieb	<i>Muffler</i>	1
500	9012SPC-01/3	Vierkant	<i>Anvil</i>	1
		Inhalt: 108, 109, 110	<i>Contents: 108, 109, 110</i>	
501	9012SPC-01/5	Stiftschlagwerk	<i>Hammer Set</i>	1
		Inhalt: 112, 113, 114, 115 (2)	<i>Contents: 112, 113, 114, 115 (2)</i>	
502	9012SPC-01/7	Zylindereinheit	<i>Cylinder Set</i>	1
		Inhalt: 301, 302, 303, 304, 305, 308, 309	<i>Contents: 301, 302, 303, 304, 305, 308, 309</i>	
502*	9012SPC-021/7N	Zylindereinheit	<i>Cylinder Set</i>	1
		Inhalt: 301*, 302*, 303*, 304*, 305*, 308*, 309*	<i>Contents: 301*, 302*, 303*, 304*, 305*, 308*, 309*</i>	
503	9012SPC-01/6	Lamellen	<i>Blades</i>	1
		Inhalt: 307 (6)	<i>Contents: 307 (6)</i>	
503*	9012SPC-022/7N	Lamellen	<i>Blades</i>	1
		Inhalt: 307* (7)	<i>Contents: 307* (7)</i>	
504	9012SPC-02/6	Ventileinheit	<i>Valve Set</i>	1
		Inhalt: 401, 402, 403, 404, 409, 417	<i>Contents: 401, 402, 403, 404, 409, 417</i>	
505	9012SPC-01/2	Ringe	<i>Ring Set</i>	1
		Inhalt: 108, 109	<i>Contents: 108, 109</i>	
506	9012SPC-03/6	Umschalter	<i>Lever Set</i>	1
		Inhalt: 204, 205 (2), 207, 208, 209	<i>Contents: 204, 205 (2), 207, 208, 209</i>	
507	9012 SPC-04/10	Gehäuse-Dichtring-Satz	<i>Housing Gasket Set</i>	1
		Inhalt: 203 (10)	<i>Contents: 203 (10)</i>	
507*	9012 SPC-023/10N	Gehäuse-Dichtring-Satz	<i>Housing Gasket Set</i>	1
		Inhalt: 203* (10)	<i>Contents: 203* (10)</i>	
508	9012 SPC-05/10	Feder-Satz	<i>Spring Set</i>	1
		Inhalt: 111 (10)	<i>Contents: 111 (10)</i>	
509	9012 SPC-06/10	Öl-Dichtring-Satz	<i>Oil Seal Set</i>	1
		Inhalt: 102 (10)	<i>Contents: 102 (10)</i>	
	* Ersatzteil für neue Ausführung / neues Design ab 2013		* <i>Spare part for new version / new design from 2013</i>	
Alle Positionen, die keine HAZET No. haben, sind nur über den HAZET-Service zu bestellen				

Zur Bestellung und für Rückfragen wenden Sie Sich bitte an unsere Service-Abteilung.
 +49 (0) 21 91/7 92 355 •  +49 (0) 21 91/7 92 523 •  service-center@hazet.de

HAZET - WERK Hermann Zerver GmbH & Co. KG •  10 04 61 • D-42804 Remscheid • Germany
 +49 (0) 21 91 / 7 92-0 •  +49 (0) 21 91 / 7 92-375 (National) •  +49 (0) 21 91 / 7 92-400 (International)
 hazet.de •  info@hazet.de