

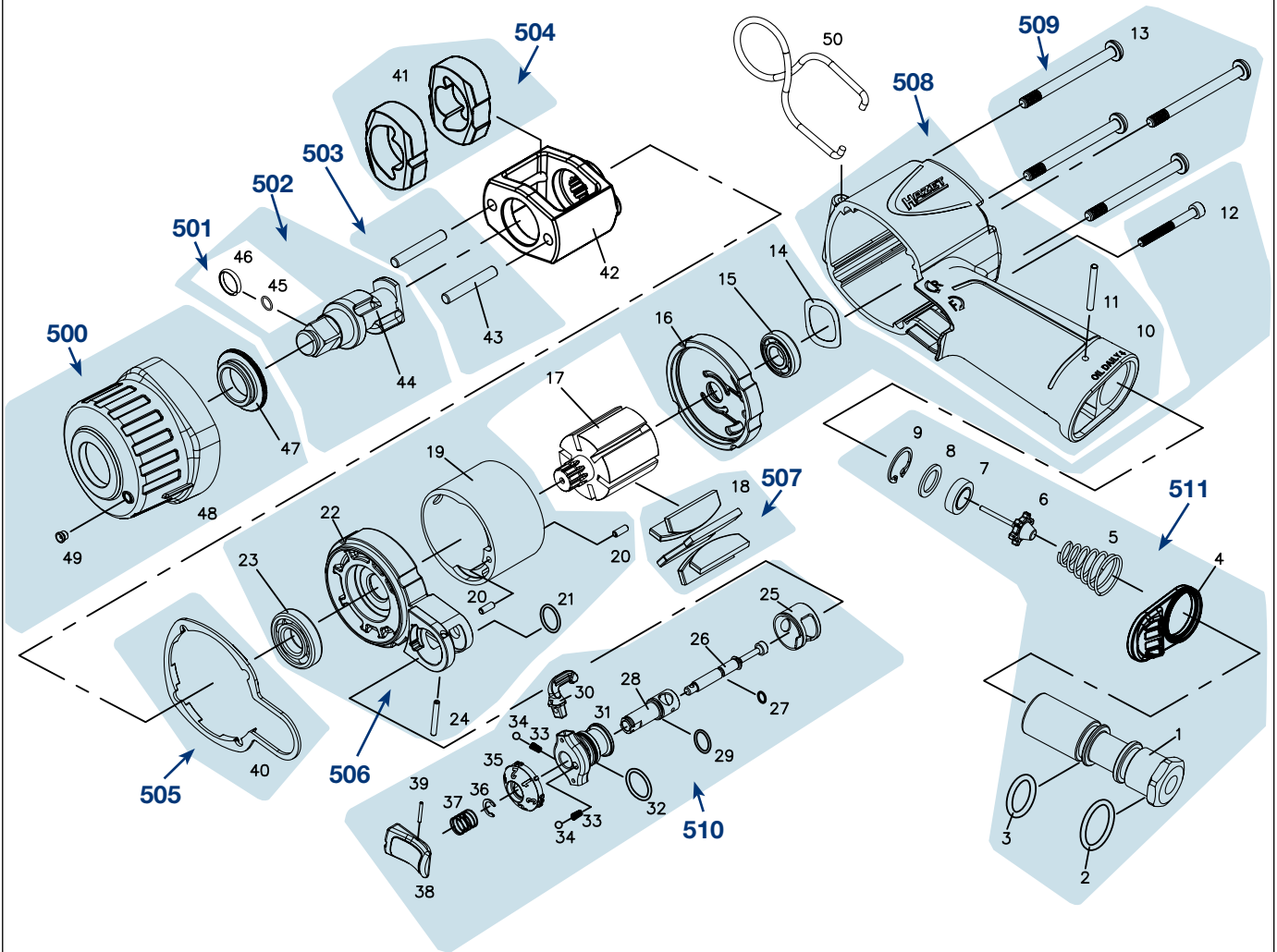

Erersatzteile 9012 MT

Spare parts - Pièces de rechange



	<i>HAZET</i> No.	Bezeichnung	Designation	Désignation	
17	9012 MT-01	Rotor Inhalt: 17	<i>Rotor</i> <i>Contents: 17</i>	<i>Rotor</i> <i>Contenu: 17</i>	1
42	9012 MT-02	Schlagwerkskorb Inhalt: 42	<i>Hammer frame</i> <i>Contents: 42</i>	<i>Cage de mécanisme de frappe</i> <i>Contenu: 42</i>	1
50	9012 MT-03	Haken Inhalt: 50	<i>Hook</i> <i>Contents: 50</i>	<i>Crochet</i> <i>Contenu: 50</i>	1
500	9012 MT-04/3	Vorderes Gehäuse Inhalt: 47, 48, 49	<i>Front housing</i> <i>Contents: 47, 48, 49</i>	<i>Boîtier avant</i> <i>Contenu: 47, 48, 49</i>	3
501	9012 MT-05/2	Ring-Satz Inhalt: 45, 46	<i>Ring set</i> <i>Contents: 45, 46</i>	<i>Jeu d'anneaux</i> <i>Contenu: 45, 46</i>	2
502	9012 MT-06/3	Vierkant mit Ring-Satz Inhalt: 44, 45, 46	<i>Anvil with ring set</i> <i>Contents: 44, 45, 46</i>	<i>Carré avec jeu d'anneaux</i> <i>Contenu: 44, 45, 46</i>	3
503	9012 MT-07/2	Stift Inhalt: 43 (2x)	<i>Hammer pin</i> <i>Contents: 43 (2x)</i>	<i>Goupille</i> <i>Contenu: 43 (2x)</i>	2

	HAZET No.	Bezeichnung	Designation	Désignation	
504	9012 MT-08/2	Hammer-Satz	<i>Hammer set</i>	<i>Jeu de marteau</i>	2
		Inhalt: 41 (2x)	<i>Contents: 41 (2x)</i>	<i>Contenu: 41 (2x)</i>	
505	9012 MT-09/5	Dichtungs-Satz	<i>Gasket set</i>	<i>Joint d'étanchéité</i>	5
		Inhalt: 40 (5x)	<i>Contents: 40 (5x)</i>	<i>Contenu: 40 (5x)</i>	
506	9012 MT-010/11	Zylindereinheit komplett	<i>Cylinder unit complete</i>	<i>Unité de vérin complète</i>	11
		Inhalt: 12, 14, 15, 16, 19, 20 (2x), 21, 22, 23, 24	<i>Contents: 12, 14, 15, 16, 19, 20 (2x), 21, 22, 23, 24</i>	<i>Contenu: 12, 14, 15, 16, 19, 20 (2x), 21, 22, 23, 24</i>	
507	9012 MT-011/6	Lamellen	<i>Blades</i>	<i>Lamelles</i>	6
		Inhalt: 18 (6x)	<i>Contents: 18 (6x)</i>	<i>Contenu: 18 (6x)</i>	
508	9012 MT-012/2	Gehäuse	<i>Housing</i>	<i>Boîtier</i>	2
		Inhalt: 10, 11	<i>Contents: 10, 11</i>	<i>Contenu: 10, 11</i>	
509	9012 MT-013/4	Gehäuseschraube	<i>Bolt</i>	<i>Vis de boîtier</i>	4
		Inhalt: 13 (4x)	<i>Contents: 13 (4x)</i>	<i>Contenu: 13 (4x)</i>	
510	9012 MT-014/17	Abzugshebel, komplett	<i>Trigger complete</i>	<i>Levier de tirage complète</i>	17
		Inhalt: 25, 26, 27, 28, 29, 30, 31, 32, 33 (2x), 34 (2x), 35, 36, 37, 38, 39	<i>Contents: 25, 26, 27, 28, 29, 30, 31, 32, 33 (2x), 34 (2x), 35, 36, 37, 38, 39</i>	<i>Contenu: 25, 26, 27, 28, 29, 30, 31, 32, 33 (2x), 34 (2x), 35, 36, 37, 38, 39</i>	
511	9012 MT-015/9	Lufteinlass	<i>Air inlet</i>	<i>Admission d'air</i>	9
		Inhalt: 1, 2, 3, 4, 5, 6, 7, 8, 9	<i>Contents: 1, 2, 3, 4, 5, 6, 7, 8, 9</i>	<i>Contenu: 1, 2, 3, 4, 5, 6, 7, 8, 9</i>	

Zur Bestellung und für Rückfragen wenden Sie sich bitte an unsere Service-Abteilung:

 +49 (0) 21 91/7 92 355

 +49 (0) 21 91/7 92 523

 service-center@hazet.de

 hazet.de/de/home/service/pneumatikmaschinen/

 hazet.de/ersatzteil-shop/









service/
pneumatikmaschinen



Ersatzteil-shop

HAZET - WERK Hermann Zerver GmbH & Co. KG •  10 04 61 • 42804 Remscheid • GERMANY

 Güldenwerther Bahnhofstraße 25 - 29 • 42857 Remscheid •  hazet.de •  info@hazet.de

 +49 (0) 21 91 / 7 92-0 •  +49 (0) 21 91 / 7 92-375 (National) •  +49 (0) 21 91 / 7 92-400 (International)