

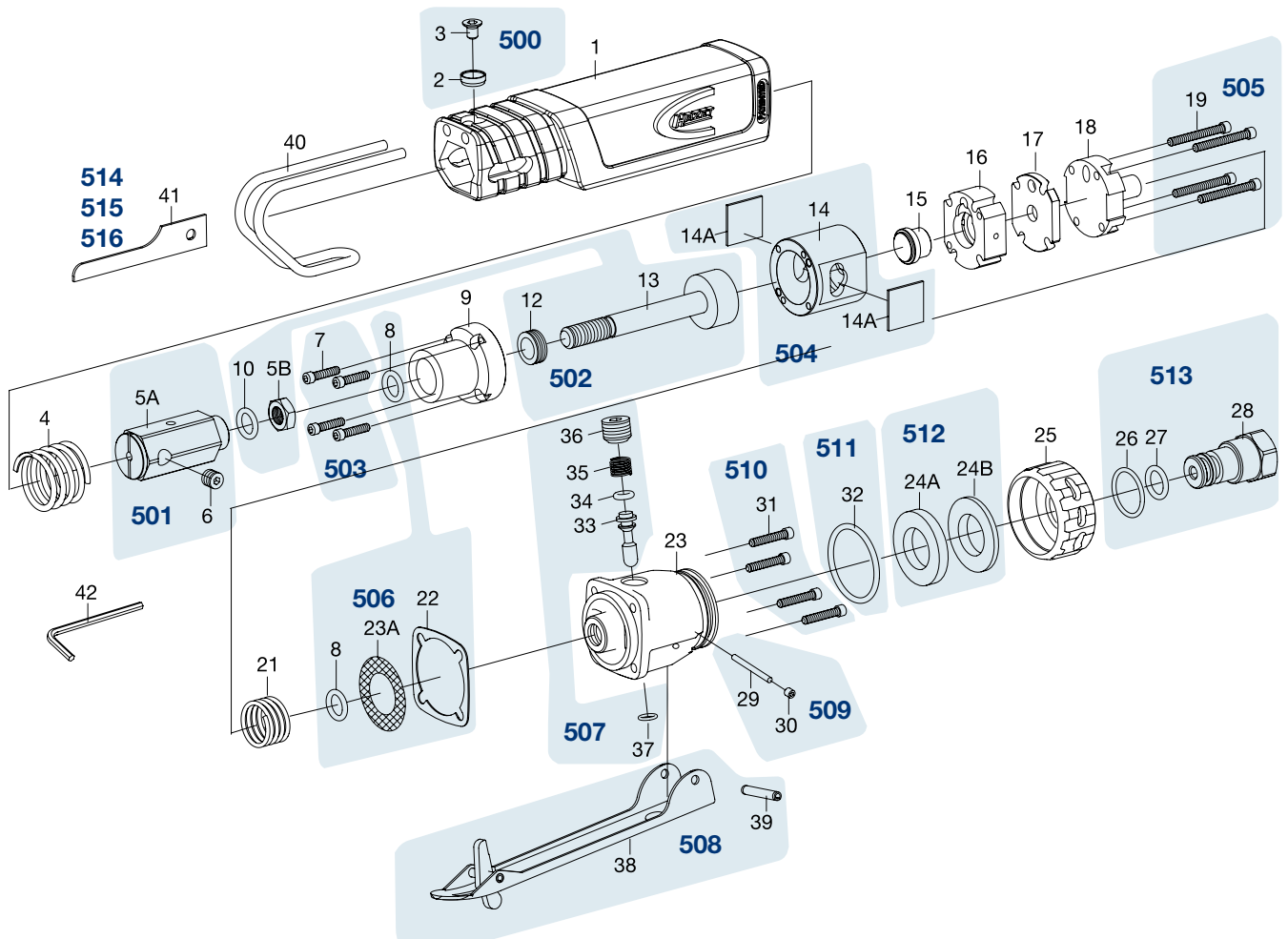



Erersatzteile 9034 P-1







	HAZET No.	Bezeichnung	Name	Désignation	
1	9034P-1-01	Gehäuse	Housing	Boîtier	1
4	9034P-1-02	Stoß Absorbierende Feder	Shock Absorbend Spring	Ressort pare-chocs	1
9	9034P-1-03	Zylinderkopf	Cylinder Head	Culasse	1
15	9034P-1-04	Automatik-Ventil	Automatic Valve	Soupape automatique	1
16	9034P-1-05	Schieberkasten	Valve Chest	Boîte à soupape	1
17	9034P-1-06	Ventilsitz	Valve Seat	Siège de soupape	1
18	9034P-1-07	Adapter	Adaptor	Adaptateur	1
21	9034P-1-08	Feder	Spring	Ressort	1
23	9034P-1-09	Hinteres Gehäuse	Rear Housing	Boîtier arrière	1
25	9034P-1-010	Schalldämpfer-Deckel	Muffler Cap	couvercle du silencieux	1
40	9034P-1-011	Haltebügel	Holder	Support	1
42		Winkelschraubendreher 3 mm	Hex Wrench 3 mm	Clé mâle de coudée 3 mm	1

	HAZET No.	Bezeichnung	Name	Désignation	
500	9034P-1-012/2	Befestigungs-Satz für Haltebügel Inhalt: 2, 3	<i>Mounting Kit for Holder</i> Contents: 2, 3	<i>Kit de fixation pour le support</i> Contenu: 2, 3	1
501	9034P-1-013/2	Sägeblatthalter Inhalt: 5A, 6	<i>Blade Holder</i> Contents: 5A, 6	<i>Support de lame de scie</i> Contenu: 5A, 6	1
502	9034P-1-014/4	Kolben-Satz Inhalt: 5B, 10, 12, 13	<i>Piston Set</i> Contents: 5B, 10, 12, 13	<i>Jeu de piston</i> Contenu: 5B, 10, 12, 13	1
503	9034P-1-015/4	Zylinderkopf-Schrauben-Satz Inhalt: 7 (4x)	<i>Cylinder Head Screw Set</i> Contents: 7 (4x)	<i>Jeu de vis de culasse</i> Contenu: 7 (4x)	1
504	9034P-1-016/3	Zylinder Inhalt: 14, 14A (2x)	<i>Cylinder</i> Contents: 14, 14A (2x)	<i>Vérin</i> Contenu: 14, 14A (2x)	1
505	9034P-1-017/4	Adapter-Schrauben-Satz Inhalt: 19 (4x)	<i>Adaptor Screw Set</i> Contents: 19 (4x)	<i>Jeu de vis de adaptateur</i> Contenu: 19 (4x)	1
506	9034P-1-018/4	Dichtungs-Satz Inhalt: 8 (2x), 22, 23A	<i>Gasket Set</i> Contents: 8 (2x), 22, 23A	<i>Jeu de joints</i> Contenu: 8, (2x), 22, 23A	1
507	9034P-1-019/5	Ventil-Einheit Inhalt: 33, 34, 35, 36, 37	<i>Valve Unit</i> Contents: 33, 34, 35, 36, 37	<i>Unité de vérin</i> Contenu: 33, 34, 35, 36, 37	1
508	9034P-1-020/2	Sicherheits-Betätigungshebel Inhalt: 38, 39	<i>Safety Lever</i> Contents: 38, 39	<i>Gâchette de sécurité</i> Contenu: 38, 39	1
509	9034P-1-021/2	Pass-Stift mit Anschlagsschraube Inhalt: 29, 30	<i>Dowel Pin with Set Screw</i> Contents: 29, 30	<i>Goupille d'ajustage avec vis</i> Contenu: 29, 30	1
510	9034P-1-022/4	Gehäuse-Schrauben Inhalt: 31 (4x)	<i>Housing Screws</i> Contents: 31 (4x)	<i>Vis de boîtier</i> Contenu: 31 (4x)	1
511	9034P-1-023/5	O-Ring-Satz Inhalt: 32 (5x)	<i>O Ring Set</i> Contents: 32 (5x)	<i>Jeu de joint torique</i> Contenu: 32 (5x)	1
512	9034P-1-024/2	Schalldämpfer-Satz Inhalt: 24A, 24B	<i>Muffler Set</i> Contents: 324A, 24B	<i>Jeu de silencieux</i> Contenu: 24A, 24B	1
513	9034P-1-025/3	Lufteinlass-Satz Inhalt: 26, 27, 28	<i>Air Inlet Set</i> Contents: 26, 27, 28	<i>Admission d'air Set</i> Contents: 26, 27, 28	1
514	9034P-1-018/5	Ersatzsägeblätter 18 Zähne (5x)	<i>Spare Blade Set</i> 18 Tooth (5x)	<i>Spare Blade Set</i> 18 Tooth (5x)	1
515	9034P-1-024/5	Ersatzsägeblätter 24 Zähne (5x)	<i>Spare Blade Set</i> 24 Tooth (5x)	<i>Spare Blade Set</i> 24 Tooth (5x)	1
516	9034P-1-032/5	Ersatzsägeblätter 32 Zähne (5x)	<i>Spare Blade Set</i> 32 Tooth (5x)	<i>Spare Blade Set</i> 32 Tooth (5x)	1

Positionen, die keine **HAZET** No. haben, können nur über den HAZET-Service bestellt werden

Zur Bestellung und für Rückfragen wenden Sie sich bitte an unsere Service-Abteilung.
 +49 (0) 21 91/7 92 355 •  +49 (0) 21 91/7 92 523 •  service-center@hazet.de

HAZET - WERK Hermann Zerver GmbH & Co. KG •  10 04 61 • D-42804 Remscheid • Germany
 +49 (0) 21 91 / 7 92-0 •  +49 (0) 21 91 / 7 92-375 (National) •  +49 (0) 21 91 / 7 92-400 (International)
www.hazet.de •  info@hazet.de